

H105Q

二段力小角度快装缓冲铝框铰链

TWO WAY CLIP ON SOFT CLOSING ALUMINUM FRAME HINGE

开启角度: 100°
 铝框钻孔孔距: 28mm
 铝材宽度: 19~23mm

Opening degree: 100°
 Holes distance on aluminum frame: 28mm
 Width of aluminum frame: 19~23mm

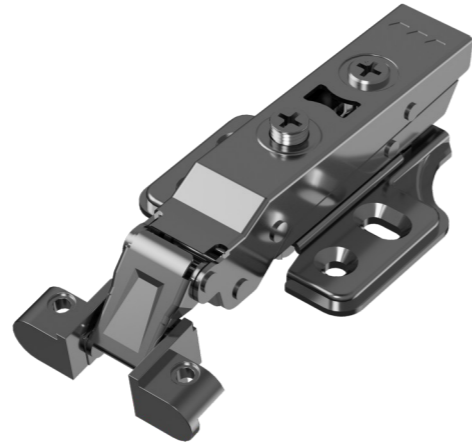

产品种类 Product category



产品盖位计算值表 Table of calculation value of product cover position

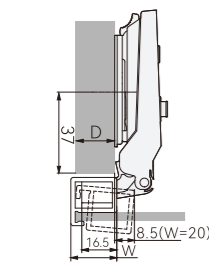

H=W-D-2					
D \ W	19	20	21	22	23
0	17	18	19	20	21
2	15	16	17	18	19
4	13	14	15	16	17

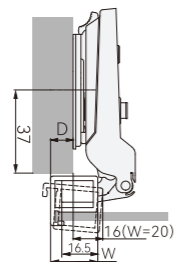

H=W-D-12					
D \ W	19	20	21	22	23
0	8	9	10	11	12
2	6	7	8	9	10
4	4	5	6	7	8

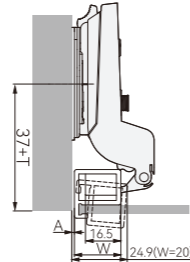

H=W+A-20					
A \ W	19	20	21	22	23
0	1	0	-1	-2	-3
2	3	2	1	0	-1
4	5	4	3	2	1

铰杯钻孔 Cup Drilling

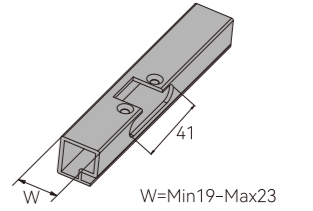
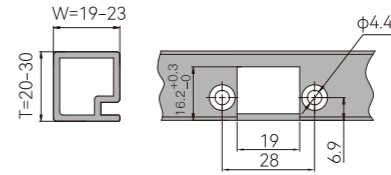
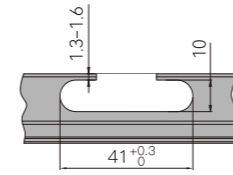

开门避让间隙值 Opening clearance value

A \ T	20	21	22	23	24	25	26	27	28	29	30
19	0.5	0.6	0.8	1.0	1.2	1.9	2.8	3.6	4.5	5.4	6.4
20	0.4	0.6	0.8	0.9	1.2	1.4	2.2	3.1	4.0	4.9	5.7
21	0.4	0.6	0.7	0.9	1.1	1.3	1.7	2.6	3.5	4.3	5.2
22	0.4	0.6	0.7	0.9	1.1	1.2	1.6	2.1	3.0	3.8	4.7
23	0.4	0.6	0.7	0.9	1.1	1.3	1.5	1.8	2.5	3.3	4.2

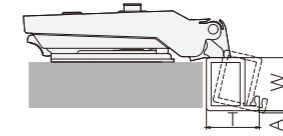

H=安装板高度 Height of mounting plate
 D=柜边上所需的面板盖 Required cover distance on side panel
 W=铝材宽度 Width of aluminum frame
 T=门身厚度 Door thickness
 L=门与侧板间隙 Gap between door and side panel
 A=面板内线/侧边外线距 Distance from inside edge of door to the outside edge of side panel

L \ T	20	21	22	23	24	25	26	27	28	29	30
19	0	0	0	0	0	0	0	0	0	0	0
20	0	0	0	0	0	0	0	0	0	0	0.1
21	0	0	0	0.2	0.3	0.4	0.5	0.7	0.8	0.9	1.1
22	0.7	0.9	1.0	1.2	1.3	1.4	1.5	1.7	1.8	1.9	2.1
23	1.7	1.9	2.0	2.2	2.3	2.4	2.5	2.7	2.8	2.9	3.1

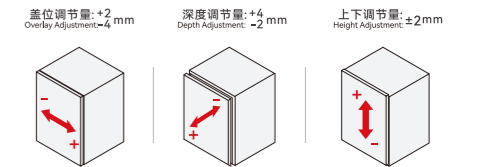
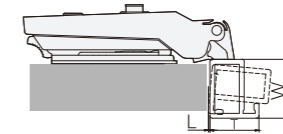

产品配件 Product accessories

底座 Mounting plate	P095-P097	木工螺丝 Wooden Screw	P100
铰臂装饰盖 Hinge arm decorative cover	P098		